

OLYMPUS[®]

Your Vision, Our Future

AUTOMATIC SEMICONDUCTOR
INSPECTION MICROSCOPE SYSTEM

MX61A

UIS2
World-leading optics



Dual-Engine

for semiconductor inspection and analysis



OLYMPUS CORPORATION has obtained ISO9001/ISO14001

*Illumination devices for microscope have suggested lifetimes. Periodic inspections are required.
Visit our Website for details.*

Specifications are subject to change without any obligation on the part of the manufacturer.

OLYMPUS[®]

OLYMPUS CORPORATION
Shinjuku Monolith, 3-1, Nishi Shinjuku 2-chome, Shinjuku-ku, Tokyo, Japan
OLYMPUS LIFE SCIENCE EUROPA GMBH
Postfach 10 49 08, 20034, Hamburg, Germany
OLYMPUS SURGICAL & INDUSTRIAL AMERICA INC.
One Corporate Drive, Orangeburg, NY 10962, U.S.A.
OLYMPUS AUSTRALIA PTY. LTD.
31 Gilby Road, Mt. Waverley, VIC 3149, Melbourne, Australia.

OLYMPUS LATIN AMERICA, INC.
5301 Blue Lagoon Drive, Suite 290 Miami, FL 33126, U.S.A.

www.olympus.com

Printed in Japan M1656E-1008B

You can perform inspection and analysis the way you want, by choosing either of the Dual Engines of the MX61A.

Performing multiple tasks in a variety of ways is fundamental to today's semiconductor manufacturing environment. Based on the above concept, Olympus has developed a Dual-Engine solution—an Inspection-Engine and an Analysis-Engine—to provide flexibility to respond to future needs as they evolve. This will allow the automation of inspection/analysis in the semiconductor field to adapt to future needs over time.

The Dual Engines fully bring out the high-performance of the MX61A, and provide automation, to fit your needs, for both inspection and analysis.



- Selectable Dual-Engine
- Superior observation images for everyone
- Optimized solutions
- Ergonomics and environment



Inspection

Analysis

Automation suited to needs with selectable Dual-Engine



- Selectable Dual-Engine
- Superior observation images for everyone
- Optimized solutions
- Ergonomics and environment

Inspection

Inspection-Engine to meet your inspection needs

The Inspection-Engine flexibly meets evolving inspection needs. What controls the entire MX61A system as an Inspection-Engine is the operation unit. The observation conditions can be called up through the operation unit at any time, and sharing among multiple operators (observers) is also possible. Auto focus compatible with a wide range of observation methods, and detailed customized settings, provide a higher level inspection environment.

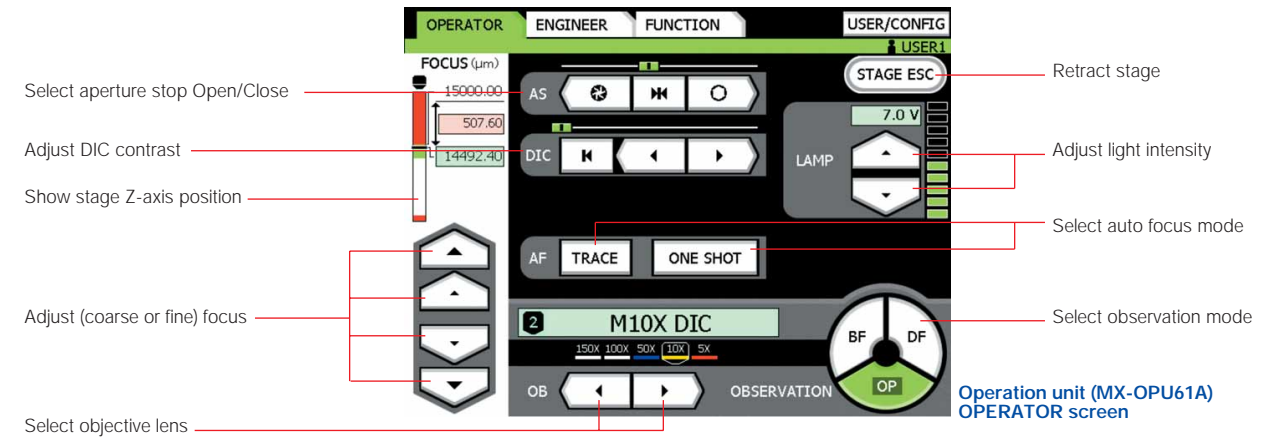

New operation unit: the best way to adapt to any operating environment.

The operation unit provides three operation screens: OPERATOR, ENGINEER and FUNCTION screens. The OPERATOR screen is designed to enable the operator to perform efficient microscopic operations. On the ENGINEER screen, more advanced operations can be performed. On the FUNCTION screen, up to six observation condition settings are shown, and any of these complicated microscopic operations can be brought up on the screen at a push of the corresponding button.

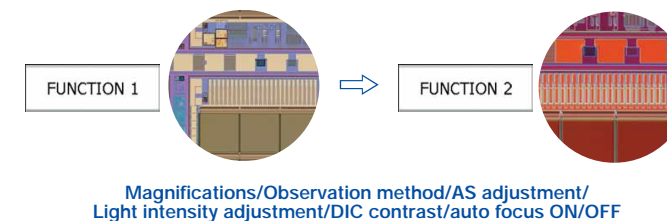
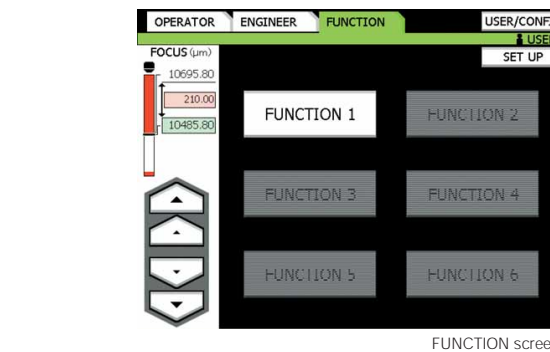
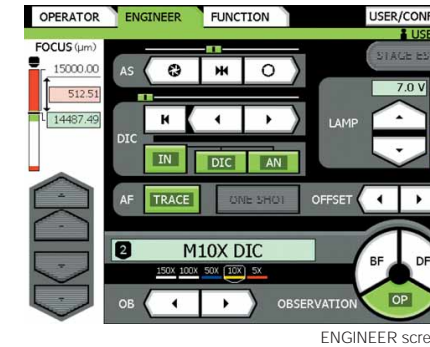

Optimum observation conditions can be established.

The aperture diaphragm (AS) works in interlock with objective magnification switching and observation method switching, the parfocality between objective lenses can be adjusted, the retardation position in DIC observations can be specified, and so forth. All these functional settings can be established on the operation unit. In addition, three USER settings can be stored in memory so that a multiple of operators (observers) can share them and use the one appropriate for a specific purpose in microscopy.



The on-screen buttons accept operations of hand in glove (MX-OPU61A)

The hand switch can be operated by touch-typing.

A hand switch is provided to allow the operator to perform microscopic inspections, such as switching of objective magnifications, switching of observational methods, etc., by touch-typing the keys on the hand switch. As one observational method is selected, an image is automatically captured according to the registered observation conditions. Using the hand switch, the operator can also switch between auto focus TRACE and ONE SHOT, tune auto focus finely, adjust the retardation position in DIC observations, adjust the brightness of a light source, or retract the stage to exchange a specimen.

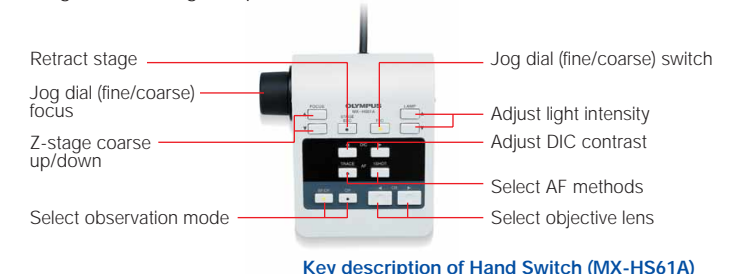

Automation suited to needs with selectable Dual-Engine



- Selectable Dual-Engine
- Superior observation images for everyone
- Optimized solutions
- Ergonomics and environment



Analysis-Engine to meet your analysis needs

The Analysis-Engine can meet ever more sophisticated analysis needs. What controls the entire MX61A system as an Analysis-Engine is the "Microscope control software".

This highly flexible software not only operates the microscope, but also controls peripheral equipment such as a digital camera or motorized stage.

Tasks which previously required multiple operations, such as sophisticated observation methods selecting Visible light and DUV light observation, can be done smoothly with a single click.

This software broadens the expandability of MX61A and supports advanced analysis requirements.



Microscope control software: MX2-BSW recipe example

Display live image

Control stage

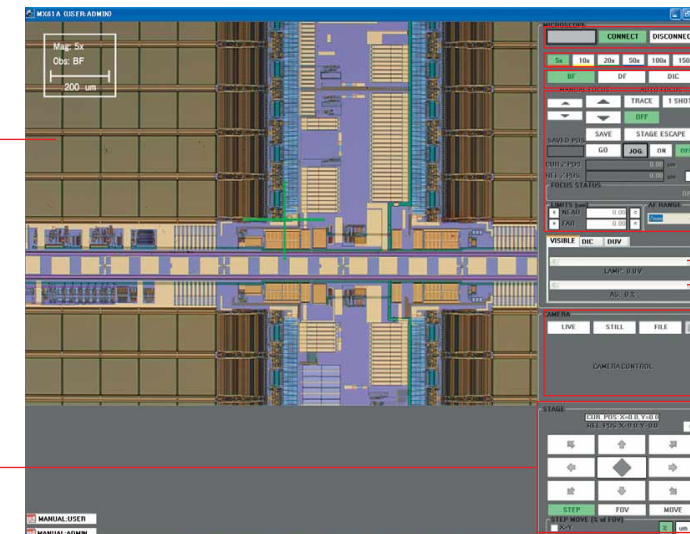

Status indicator
Select or Rotate objective lens position
Select observational method

Focus settings

Adjust light intensity

Adjust DIC contrast

Control camera

Peripheral devices can be controlled automatically.

The microscope control software MX2-BSW makes it possible to control microscope operations in a variety of ways, including AF, motorized units such as the DUV observation system and motorized stage^{*1}, etc. A digital camera^{*2} can also be controlled. If the operator clicks a point of interest on a live image shown on the monitor using the motorized stage, he or she can jump to the center of a field of view instantly. This makes it easier to perform a series of operations,

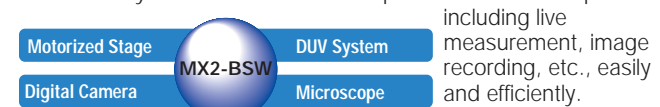

including live measurement, image recording, etc., easily and efficiently.

*1. The model is recommended by Olympus.

*2. The Olympus DP20 or a digital camera compatible with IEEE1394 can be used.

Easily customizable software.

The user can customize the operation screen to make it easier to use; for example, customizing the position, size, etc., of the control button. If a set of operations are registered by combining action commands, a click on the registered set of operations allows the operator to perform microscope operations fully automatically.

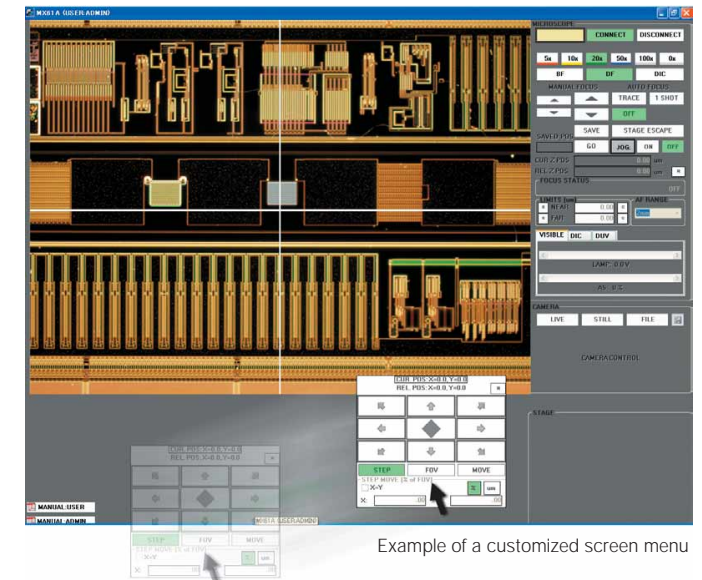
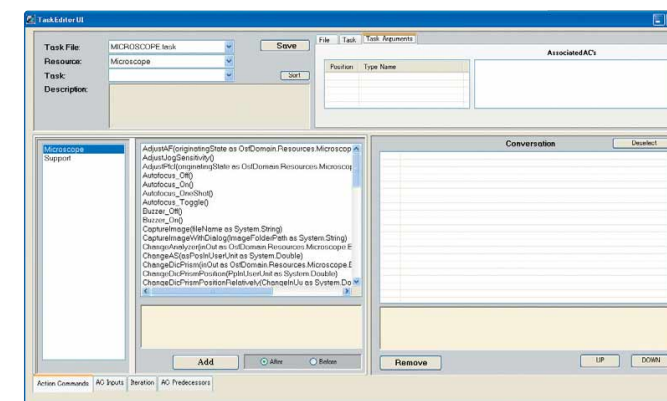

Example of a customized screen menu

The combined use of PC and operating unit controls is possible.

Microscope operations can be controlled from the operating parts (hand switch and joystick handle) that work independent of a PC. The feature whereby main microscope operations can be performed from the hand switch adds to the ease and comfort of microscope operations.

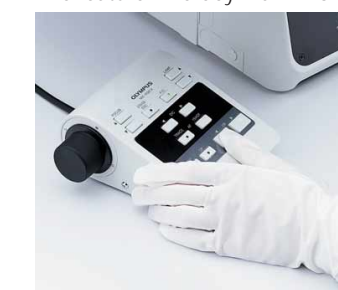

Key-touching operation with Hand Switch (MX-HS61A)

Inspection/analysis with superior observation images...every time



- Selectable Dual-Engine
- Superior observation images for everyone
- Optimized solutions
- Ergonomics and environment



High Imaging performance.

The best imaging performance, particularly that in Brightfield and Darkfield, has been increased through the introduction of the new UIS2 optical system. In brightfield observation, crisp, natural color reproduction has been achieved. In Darkfield image brightness has been increased by an average of over four times as compared with the famous Olympus UIS series systems.

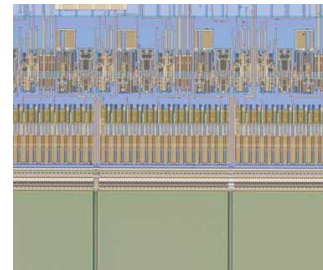

Brightfield image (UIS2)

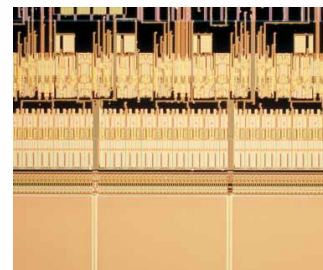

Darkfield image (UIS2)

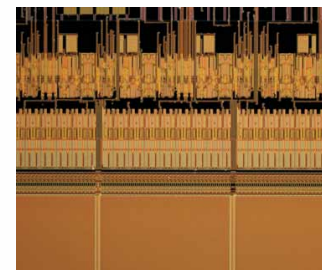

Darkfield image (conventional)

Light intensity is automatically adjusted to the optimum level.

Light intensity and contrast adjustments work in a way whereby they are automatically and optimally adjusted when the objective lens magnification or observational method is changed. This contributes to increasing the observational speed and reducing fatigue.

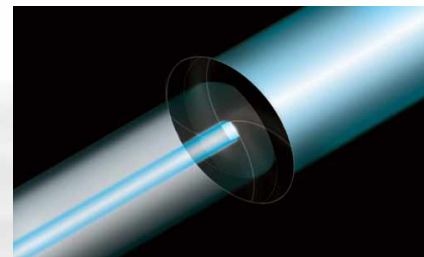

Diverse observational methods are supported.

The UIS2 objective lens series capable of high performance in DUV (Deep Ultra Violet), visible light, and near-infrared microscopy optics that can be used in combination with the MX61A. This allows MX61A to be used in many different observations: brightfield, darkfield, Differential Interference Contrast (DIC), fluorescence, near-infrared, and DUV. To switch from one observational method to another, the user can simply select one of three positions provided: brightfield, darkfield, and optional.



UIS2 objective lenses MPLFLN(-BD) series

The active AF capable of observing a wide range of devices.

U-AFA2M series, a further advanced version of the active-type laser auto focus capable of high speed and accuracy. The introduction of a newly developed multi-spot sensor has enabled a substantial increase Autofocus stability by eliminating the effects of vertical topography on the specimen. Now the new U-AFA2M can perform exceptionally well in all observation methods, faster more repeatably. The U-AFA2M series comprises VIS (Visible) type and VIS/DUV compatible type.



Exclusive DUV objective lens (center)

UIS2 objective lenses with the highest parcentration.

To accommodate the smaller field of view found in digital imaging, the centration accuracy between high-magnification objective lenses have been improved 2x over the famous UIS series lenses. This has made a dramatic improvement in image centration when high power objectives are used. This means that the use of video monitors for imaging has become even more convenient.

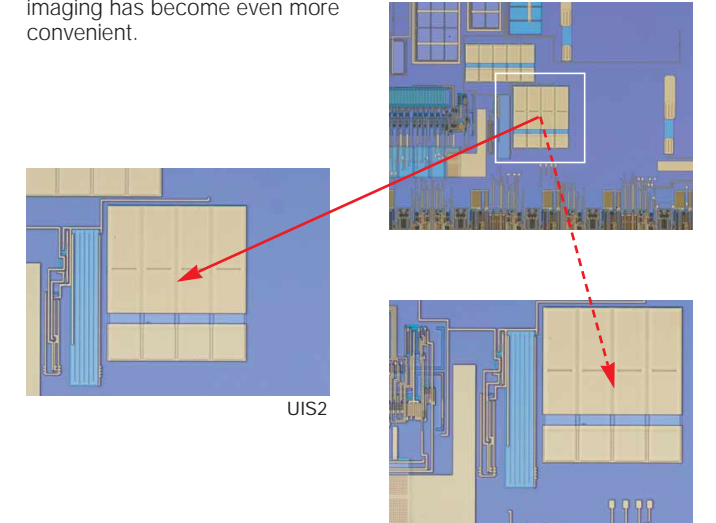

UIS2

UIS

The "Dual-Engine" allows UIS2 to deliver the high performance fully.

Brightfield

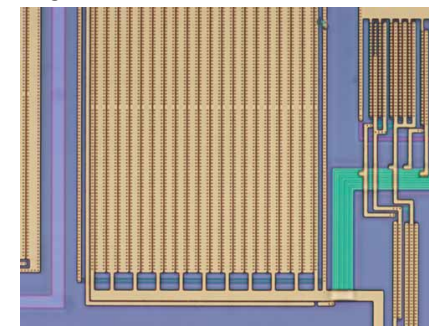

Darkfield

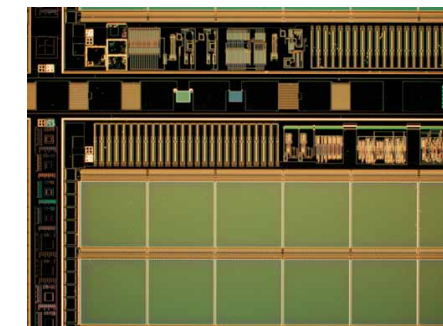

DIC

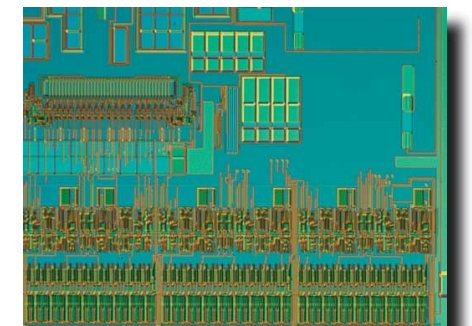

Fluorescence

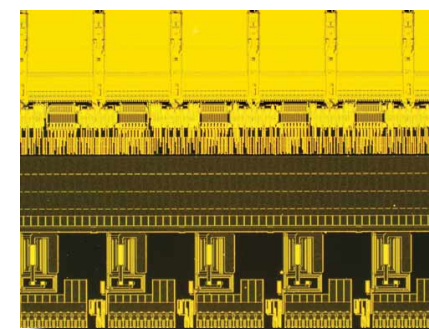

B excitation (MPLFLN10X)

Deep ultraviolet

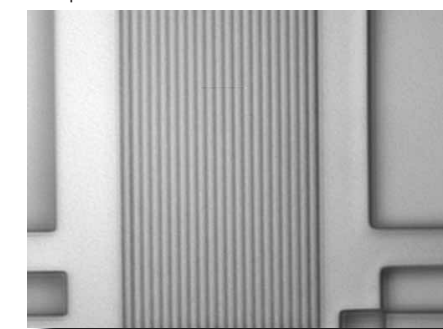

0.15 μm line/space

Near infrared light VIS (the same location)

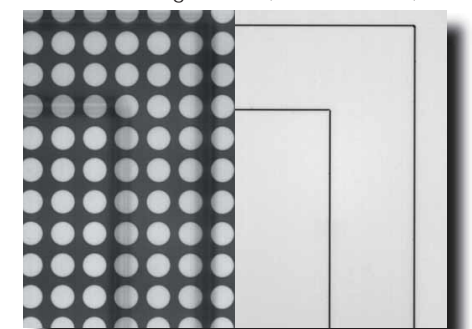

Cavity structure in MEMS device

The optimized solutions for your specific needs



- Selectable Dual-Engine
- Superior observation images for everyone
- Optimized solutions
- Ergonomics and environment

Inspection

Basic configuration *Standard system*



Optimized performance in wafer inspection *Wafer loader system*



Optimized view and image data management *Digital imaging system*



Auto Focus (VIS)

The AF system supports all visible (VIS) light observation modes.

The AF set up is made on the operation module. AF can be operated using the hand switch, it can also be controlled with the operation module.



Wafer Loader

The wafer loading system increases the efficiency of wafer inspections.

A combination of the wafer loading system AL110 and a motorized stage MS200 provides a powerful support for wafer inspection operations. A wafer up to 200 mm is transported to the stage safely, and points to be inspected can be located consecutively based on a predefined recipe.

Note: For information on a 300 mm compatible system, please contact your Olympus Representative.



Motorized DIC

The motorized DIC system features hand control.

By attaching the optional motorized DIC components. DIC imaging is completely automated. Prism position can also be set using the hand switch. The MPLFLN series objective lenses with magnification range of 5x to 150x can be utilized.



Digital Imaging

The digital imaging system allows the operator to inspect a wafer by viewing a monitor.

Using the Olympus DP20, the operator views and records live images in a comfortable position. Live images in high resolution are displayed on the monitor in real time.

Custom wafers can be handled: If wafers are inspected in transmitted light illumination or if the thickness of an specimen to be inspected is 24 mm or more, please contact your Olympus Representative.

The optimized solutions for your specific needs



- Selectable Dual-Engine
- Superior observation images for everyone
- Optimized solutions
- Ergonomics and environment

Scanning Stage and Digital Documentation Integration System *Automated microscopy operation system*



Ultra high resolving power in Visible/DUV light *Fully automated DUV system*



AF
Auto Focus (VIS/DUV)

The AF system can be controlled using either a PC or the hand switch (Visible to DUV light). The AF set up and operation can be performed using the microscope control software, MX2-BSW. AF system operation can also be performed by using the hand switch.

X Y
Motorized Stage

The motorized stage system is compatible with wafers up to 300 mm. High-precision motorized stages compatible with up to 300 mm* wafers are available. Advanced inspection and failure analyses are possible by using these stages.
*For information about 300mm compatible stage, please contact your Olympus Representative.

DIC
Motorized DIC

The motorized DIC system can be controlled using either a PC or the hand switch. Motorized DIC observation can be performed using the microscope control software, MX2-BSW. The UIS2 series objective lenses with a magnification range of MPLFLN series 5x to 150x can be used.

DIGITAL
Digital Imaging

The imaging system allows a digital camera to be controlled on a PC. Images captured by the DP series digital cameras recommended by Olympus can be controlled.

0.08 μm
Deep Ultra Violet

Non-cemented DUV (Deep Ultra Violet) optical technology with super long-term reliability.

DUV observation can be selected with a single click. The motorized DUV observation system can be activated by a single click of a button.

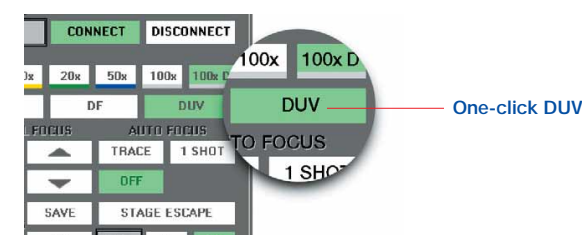

The AF system can be controlled using either a PC or the hand switch. The AF set up and operation can be performed using the microscope control software, MX2-BSW. AF system operation can also be performed by using the hand switch.

Easy layout. The DUV system is controlled via a PC, allowing the lamp house box to be located under the table sparing valuable table space for operator comfort and safety.



Motorized UV248 light source box

Custom wafers can be handled: If wafers are inspected in transmitted light illumination or if the thickness of an specimen to be inspected is 24 mm or more, please contact your Olympus Representative.

Operator-friendly, environmentally-friendly automation



- Selectable Dual Engine
- Superior observation images for everyone
- Optimized solutions
- Ergonomics and environment



Compliance with SEMI S2 and S8.

MX61A complies with SEMI S2-0706 and S8-0705, CE, and other industry standards and specifications. A high level of reliability is verified with respect to ergonomic design, safety precautions, etc.

Tilting observation tubes offers two options.

To allow the operator to make observations in a comfortable position, tilting tubes with different optical path split ratios, MX-SWETTR (100:0, 0:100) and U-SWETTR-5 (100:0, 20:80), are available as optional accessories. Either type that suits a specific application should be selected.

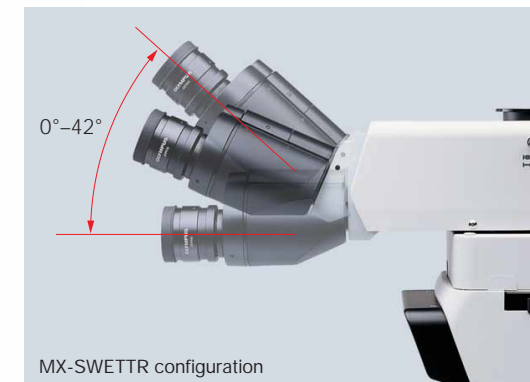

| Model | Inclination angle | Light path selector (eyepiece/video port) |
|------------|-------------------|---|
| MX-SWETTR | 0° - 42° | 100:0 / 0:100 |
| U-SWETTR-5 | 0° - 35° | 100:0 / 20:80 |

Antistatic function.

The microscope body and observation tube have an antistatic finish and a breath shield to prevent a specimen from being contaminated.



The motorized revolving nosepiece for use in a clean-room environment.

Two motorized revolving nosepieces are offered for the MX61A system. They have great durability and are suitable for use in a clean-room environment. A new type of motor has been introduced to motorized 6-position and 5-position centerable nosepieces for Brightfield and Darkfield illumination. High-speed and quiet magnification switching has been realized.



High quakeproof frame.

A high-rigidity, vibration-resistant frame is used. Image blurs do not occur even at high magnifications in DUV observation.

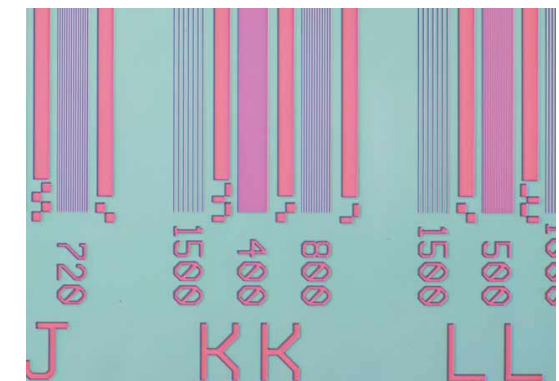

SYSTEM DIAGRAM

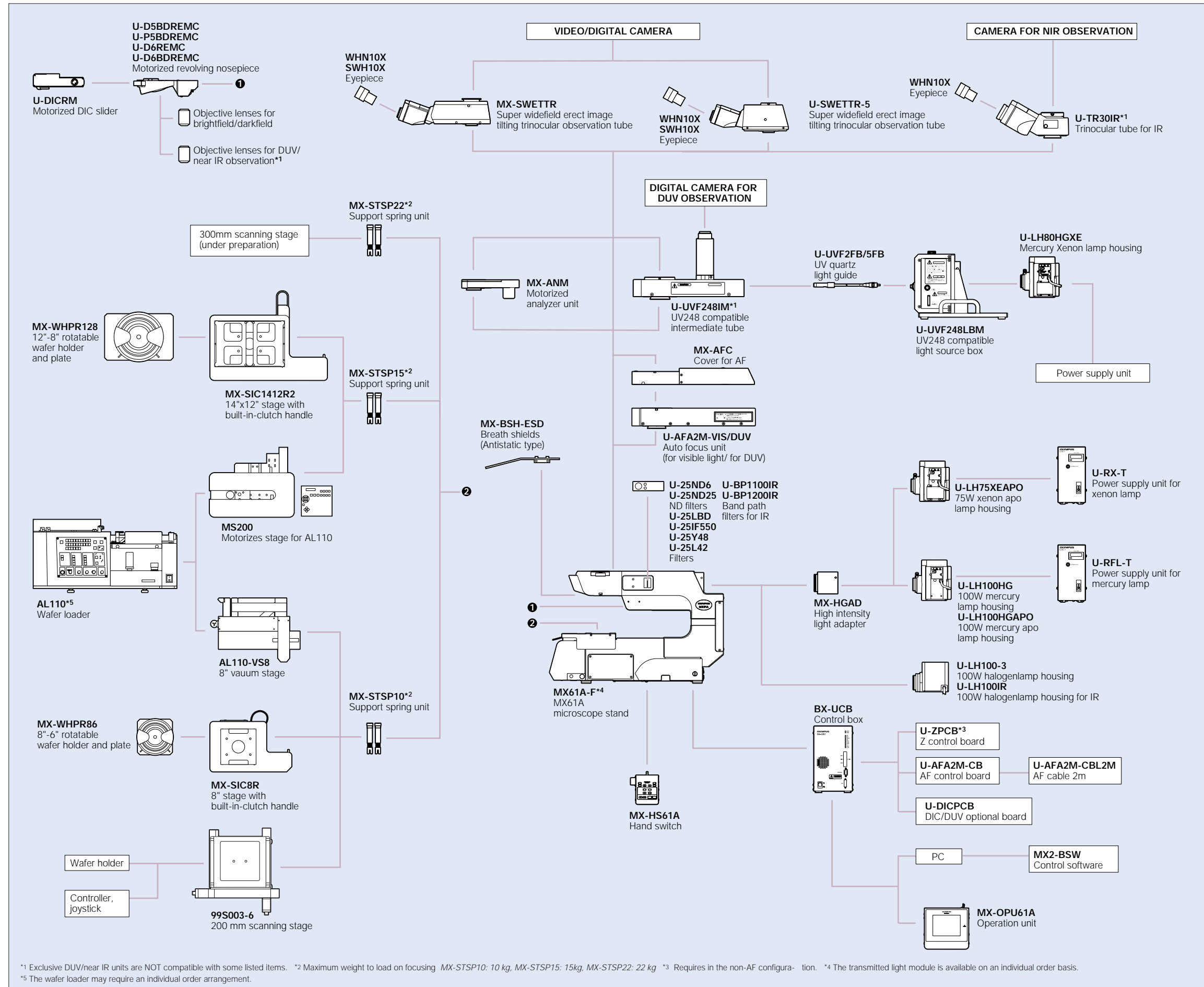

*1 Exclusive DUV/near IR units are NOT compatible with some listed items. *2 Maximum weight to load on focusing MX-STSP10: 10 kg, MX-STSP15: 15kg, MX-STSP22: 22 kg *3 Requires in the non-AF configuration. *4 The transmitted light module is available on an individual order basis. *5 The wafer loader may require an individual order arrangement.

OBJECTIVE LENS



| Objective lenses | Magnifications | N.A. | W.D. (mm) | Cover Glass Thickness *5 (mm) | Resolution *2 (µm) |
|------------------|----------------|--------------|--------------|-------------------------------|--------------------|
| MPLAPON | 50x 100x | 0.95 0.95 | 0.35 0.35 | 0 0 | 0.35 0.35 |
| MPLFLN | 1.25x *3* | 0.04 | 3.5 | — | 8.39 |
| | 2.5x *4 | 0.08 | 10.7 | — | 4.19 |
| | 5x | 0.15 | 20.0 | — | 2.24 |
| | 10x | 0.30 | 11.0 | — | 1.12 |
| | 20x | 0.45 | 3.1 | 0 | 0.75 |
| | 50x 100x | 0.80 0.90 | 1.0 1.0 | 0 0 | 0.42 0.37 |
| MPLFLN-BD | 5x | 0.15 | 12.0 | — | 2.24 |
| | 10x | 0.30 | 6.5 | — | 1.12 |
| | 20x | 0.45 | 3.0 | 0 | 0.75 |
| | 50x | 0.80 | 1.0 | 0 | 0.42 |
| | 100x | 0.90 | 1.0 | 0 | 0.37 |
| MPLFLN-BDP | 5x | 0.15 | 12.0 | — | 2.24 |
| | 10x | 0.25 | 6.5 | — | 1.34 |
| | 20x | 0.40 | 3.0 | 0 | 0.84 |
| | 50x | 0.75 | 1.0 | 0 | 0.45 |
| | 100x | 0.90 | 1.0 | 0 | 0.37 |
| LMPLFLN | 5x | 0.13 | 22.5 | — | 2.58 |
| | 10x | 0.25 | 21.0 | — | 1.34 |
| | 20x | 0.40 | 12.0 | 0 | 0.84 |
| | 50x | 0.50 | 10.6 | 0 | 0.67 |
| | 100x | 0.80 | 3.4 | 0 | 0.42 |
| LMPLFLN-BD | 5x | 0.13 | 15.0 | — | 2.58 |
| | 10x | 0.25 | 10.0 | — | 1.34 |
| | 20x | 0.40 | 12.0 | 0 | 0.84 |
| | 50x | 0.50 | 10.6 | 0 | 0.67 |
| | 100x | 0.80 | 3.3 | 0 | 0.42 |
| MPLN *3 | 5x | 0.10 | 20.0 | — | 3.36 |
| | 10x | 0.25 | 10.6 | — | 1.34 |
| | 20x | 0.40 | 1.3 | 0 | 0.84 |
| | 50x | 0.75 | 0.38 | 0 | 0.45 |
| | 100x | 0.90 | 0.21 | 0 | 0.37 |
| MPLN-BD *1*3 | 5x | 0.10 | 12.0 | — | 3.36 |
| | 10x | 0.25 | 6.5 | — | 1.34 |
| | 20x | 0.40 | 1.3 | 0 | 0.84 |
| | 50x | 0.75 | 0.38 | 0 | 0.45 |
| | 100x | 0.90 | 0.21 | 0 | 0.37 |
| SLMPLN | 20x | 0.25 | 25 | — | 1.34 |
| | 50x | 0.35 | 18 | 0 | 0.96 |
| | 100x | 0.6 | 7.6 | 0 | 0.56 |
| LCPLFLN-LCD | 20x | 0.45 | 8.3 - 7.4 | 0 - 1.2 | 0.75 |
| | 50x | 0.70 | 3.0 - 2.2 | 0 - 1.2 | 0.48 |
| | 100x | 0.85 | 1.2 - 0.9 | 0 - 0.7 | 0.39 |



| Objective lenses | Magnifications | N.A. | W.D. (mm) | Cover Glass Thickness *5 (mm) | Resolution *2 (µm) |
|------------------|----------------|------|-----------|-------------------------------|--------------------|
| LMPlan-IR *3 | 5x | 0.10 | 20.0 | — | — |
| | 10x | 0.25 | 18.5 | — | — |
| | 20x | 0.40 | 8.1 | — | — |
| | 50x | 0.55 | 6.0 | — | — |
| | 100x | 0.80 | 3.4 | — | — |
| MPlan-IR *3 | 100x | 0.95 | 0.3 | — | — |

* "BD" = "Brightfield/darkfield" objective lenses
 *1 Slight vignetting may occur in the periphery of the field when MPLN-BD series objective lenses are used with high-intensity light sources such as mercury and xenon for darkfield observation.
 *2 Resolutions calculated with aperture iris diaphragm wide open.
 *3 Limited up to F.N. 22. No compliance with F.N. 26.5.
 *4 Analyzer and polarizer are recommended to the usage with MPLFLN1.25x or 2.5x.
 *5 — : Applicable to the view of specimens with/without a cover glass
 0 : Applicable to the view of specimens without a cover glass

MX61A SPECIFICATIONS

| Item | Specifications |
|---------------------------------|--|
| Optics | Universal Infinity System (UIS2/UIS) optics |
| Illumination system | Reflected light illumination system (FN 26.5) 12 V, 100 W halogen bulb (pre-centered). Motorized brightfield/darkfield selection by mirror + 1 mirror unit (* optional). * Any desired observation mirror unit can be added. Motorized aperture iris diaphragm built in. (Preset value for each objective lens, opened automatically for DF observation.) Available reflected light observation methods: ① Brightfield; ② Darkfield; ③ DIC; ④ Simplified Polarized Light; ⑤ Fluorescent Light; ⑥ near IR; ⑦ DUV ⑦ requires MX2-BSW (PC) and cannot be configured with the MX-OPU61A operation unit. |
| Electrical system | BX-UCB control box (12 V, 100 W). Input rating: 100-120/220-240 V AC, 50/60 Hz, 3.5/1.5 A Indicator LEDs: RMT (Remote) LED, ERR (Error) LED, module installation check LEDx 10. Option slots: Power capacity (single slots) |
| Motorized focusing mechanism | High-rigidity, 2-guide cross-roller guide system Ball screw + Stepping motor drive. Stroke: 25.4 mm. Fine adjustment sensitivity: Below 1 μm. Resolution: 0.01 μm. Maximum speed: 5 mm/sec. (Default: 3 mm/sec.) Maximum load (including the stage holders) • MX-STSP10: 10 kg • MX-STSP15: 15 kg • MX-STSP22: 22 kg |
| Auto focusing unit (optional) | Pupil-division reflection active auto focusing using a laser diode and 2-division detector. Multi-spot projection. Laser wavelength: 785 nm (Class 1: JIS C6802 (2005), IEC60825-1 (2001), CDRH). Tracking range : 5x: ±5000 μm and more 10x: ±2000 μm, 20x: ±1100 μm, 50x: ±400 μm, 100x: ±100 μm, 150x: ±50 μm, DUV: ±50 μm (only for DUV) <i>The tracking range is dependent on the specimen reflectivity and objective lens in use.</i> |
| Observation tube | Super-widefield erect image trinocular tube (FN 26.5) MX-SWETTR (Optical path select 100:0, 0:100, tube inclination angle 0 to 42 degrees) U-SWETTR-5 (Optical path select 100:0, 20:80, tube inclination angle 0 to 35 degrees) Infra-red wide field trinocular tube (FN 22) U-TR30IR (Optical path select 100:0, 0:100, tube inclination angle 30 degrees (fixed)). |
| Motorized revolving nosepiece | Brightfield 6-position motorized revolving nosepiece: U-D6REMC, Brightfield/darkfield 5-position motorized revolving nosepiece: U-D5BDREMC, Brightfield/darkfield 5-position centerable motorized revolving nosepiece: U-P5BDREMC, Brightfield/darkfield 6-position motorized revolving nosepiece: U-D6BDREMC |
| UV248 optical system (optional) | Wavelength: 248 ± 4 nm Light source: 80W mercury xenon lamp Objective lens: Exclusive DUV objective lens / NA 0.9, WD 0.2 mm Intermediate magnification: 2.5x Filed number: 12.5 (Actual field of view 50 μm) Usage environment: 23±5°C Brightness adjustment: Motorized controlled from 0 through 100 % transmission UV light guide: 2 m long or 5 m long Controlled via PC only |
| Controllers | Operation Unit MX-OPU61A LCD touch panel with built-in control software. Enables microscope controls and observation condition setups. Hand Switch MX-HS61A Enables microscope controls (using 1 jog dial + 14 buttons). Software MX2-BSW (for a PC use) Application software for controlling the MX61A and motorized modules. Computer environment OS: Windows XP Professional. CPU: Pentium 4, 2 GHz or faster. Memory: 512 MB or more. HDD: 40 GB or more. Display: 1024 x 768 or more. |
| Stage | MX-SIC1412R2: 14x12-inch stage with coaxial knobs on the bottom right • Stroke: 356 x 305 mm (Transmitted illumination field 356 x 284 mm). • Roller guide type sliding belt drive (rack-less). • Grip clutch mechanism (Belt interlock-release system). MX-SIC8R: 8x8-inch stage with coaxial knobs on the bottom right. • Stroke: 210 x 210 mm (Transmitted illumination field 189 x 189 mm). • Roller guide type sliding belt drive (rack-less). • Grip clutch mechanism (Belt interlock-release system). 99S003-06 200mm Scanning Stage • Stroke: 203 x 203 mm <i>Please consult the Olympus with 300mm scanning stage.</i> |
| Dimensions & weight | Dimensions: Approx. 711 (W) x 853 (D) x 552 (H) mm. Weight: Approx. 56 kg (Microscope stand only: Approx. 31 kg) <i>In the MX61A configuration of the following items: the MX-SIC1412R2 stage, MX-WHPR128 wafer holder, U-D6BDREMC motorized revolving nosepiece, U-AFA2M-VIS active auto focusing unit, MX-AFC MX Cover for AF, MX-SWETTR observation tube and U-LH100-3 lamp housing are combined.</i> |
| Operating environment | • This device is designed for use in industrial environments for the EMC performance. (Class A device). Using it in a residential environment may affect other equipment in the environment. • Indoor use. • Altitude: Max. 2000 meters. • Ambient temperature: 10° through 35°C (50° through 95° F). • Relative humidity: 80% for temperatures up to 31°C (88°F) (without condensation), decreasing linearly through 70% at 34°C (93°F), 60% at 37°C (99°F) to 50% relative humidity at 40°C (104°F). • Supply voltage fluctuations: ±10%. • Pollution degree: 2 (in accordance with IEC60664). • Installation (overvoltage) category: II (in accordance with IEC60664) |

MX61A Basic Configuration (combined with 200 mm standard stage)

(unit: mm)

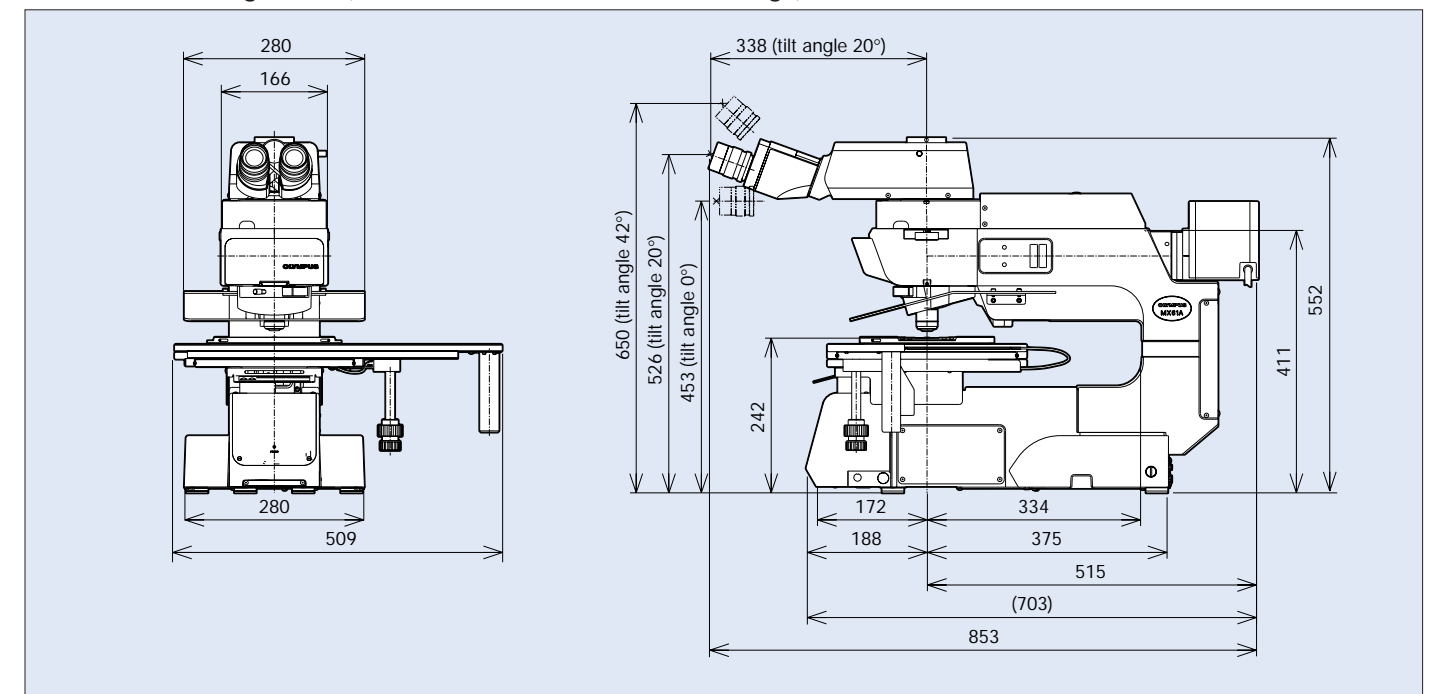
MX61A DUV Advanced Configuration (combined with 300 mm standard stage)

(unit: mm)

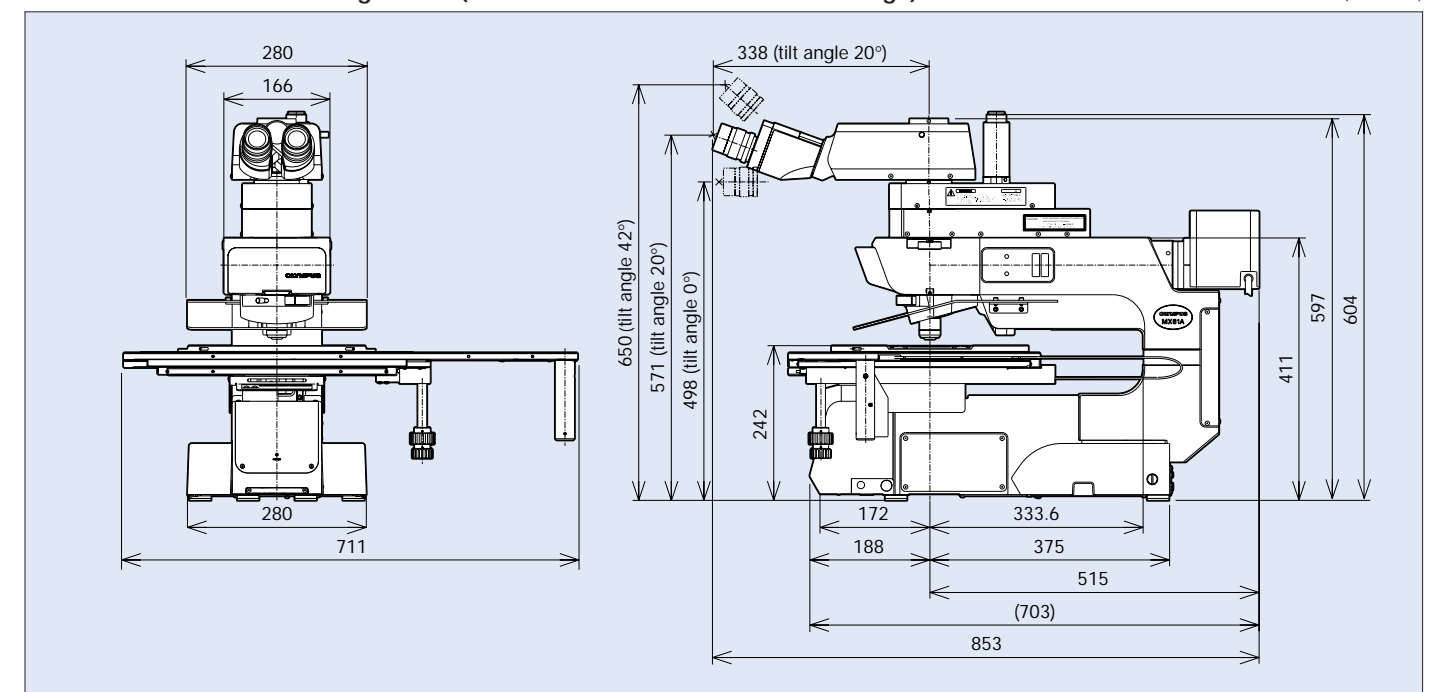
MX-OPU61A operation unit dimensions

(unit: mm)

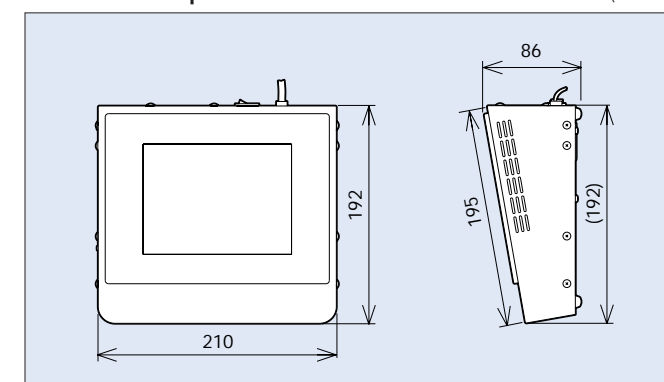
MX-HS61A hand switch dimensions

(unit: mm)

