

Capture a Complete Spectrum of Functionality for Research,
Medical Education and Training, and Consultation

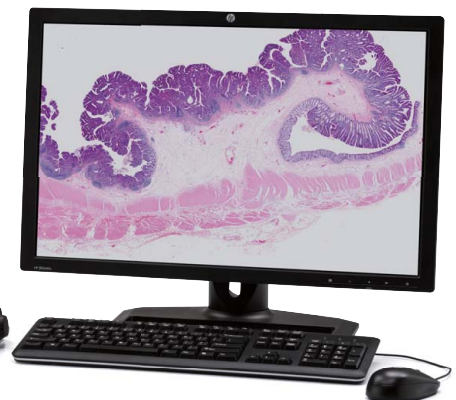

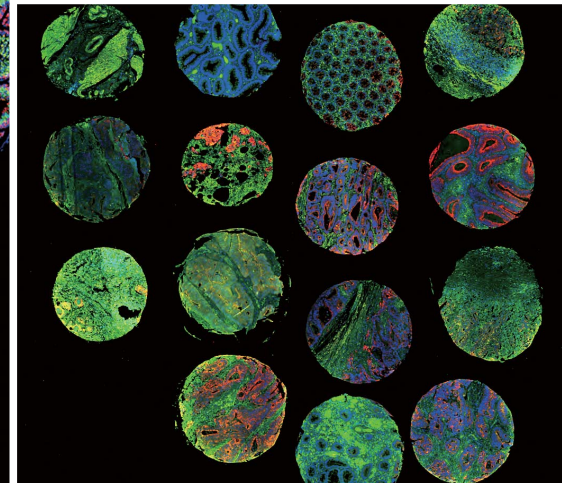

Advanced Virtual Slide System

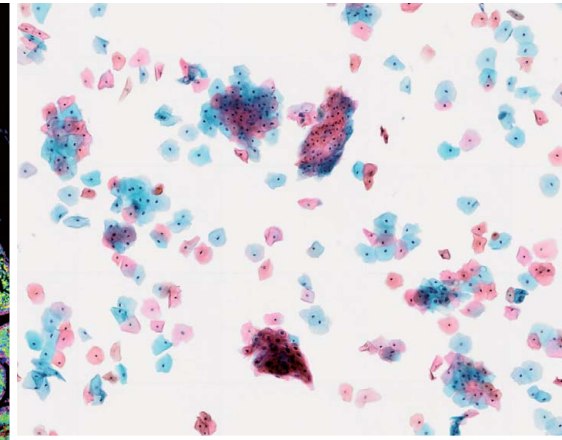
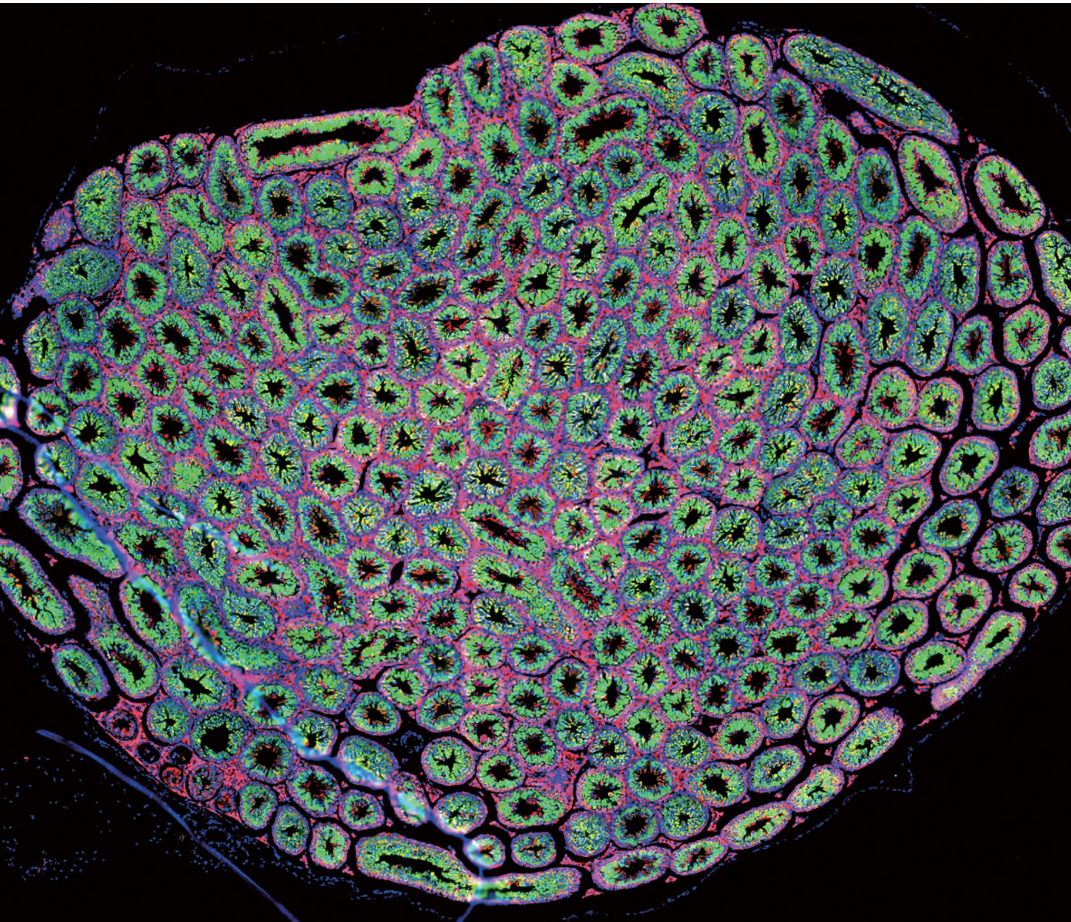

Brightfield/Fluorescence Observation Configuration
(With 100-slide Storage Capacity)

Islet of insulin-deficient diabetic mouse, DAPI (blue), insulin (red)

Image data courtesy of
Daisuke Sakano, Ph.D., Shoen Kume, Ph.D.
Department of Stem Cell Biology, Institute of Molecular Embryology and Genetics, Kumamoto University

An Ideal Choice for State-of-the-Art Research Facilities and Digital Learning Programs

Enhanced Research Tool for Brightfield and Fluorescence

The VS120 not only creates high resolution brightfield images, but also can scan in full multi-fluorescence mode. Utilizing virtual microscopy for fluorescence imaging helps to minimize problems associated with damaging and fading of sensitive fluorescence samples. An innovative new algorithm makes image stitching more precise than ever — enabling high-level accuracy that can be applied from small animal brain slices to large specimens. The VS120 also switches seamlessly between micro and macro observation to enable swift viewing of regions of interest and overall structures alike.

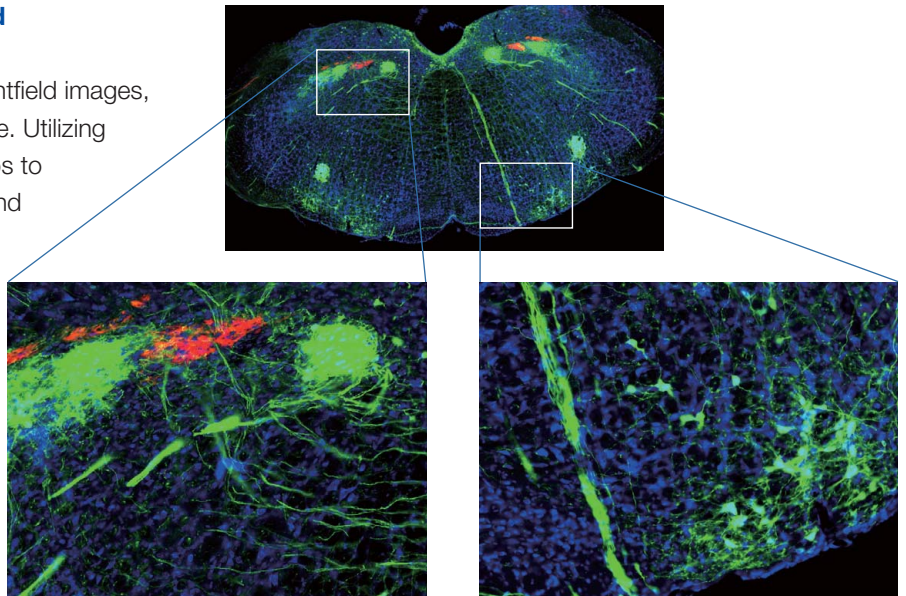

Advanced Medical Education and Collaboration

The VS120 allows multiple viewers to study virtual slide specimens simultaneously via simple server access, regardless of time and location — providing an ideal solution for medical instruction, Q&A session and remote collaboration.

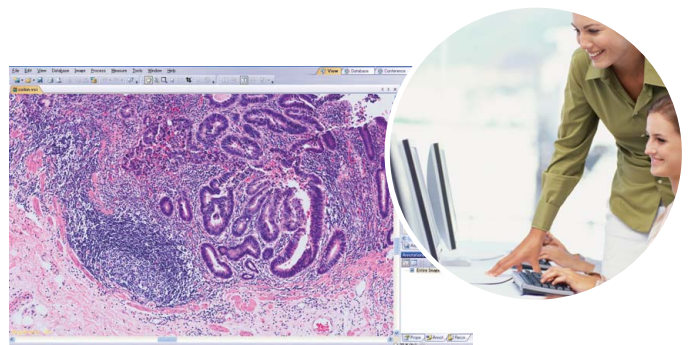

Remote Conferencing and Consultation

Virtual slides can be archived to a database, enabling network-based remote retrieval at any time through the Olympus NetImage Server (NISSQL). Images are stored at high resolution, and multiple clients can review and even synchronize elements such as specific observation areas to facilitate efficient review and discussion.

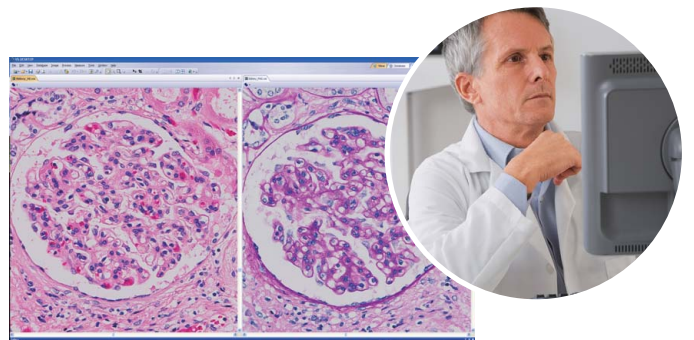

High-Detail, High-Precision, Rapid Scanning

Wide Range of Objectives from 2x to 100x

The VS120 comes standard with Olympus UPLSAPO 2x, 10x, 20x and 40x objectives, allowing the user to choose an objective most suitable for his or her research needs. Automatic specimen recognition capability limits scanning to the specimen area, with high-level color fidelity and image quality. Additionally, UPLSAPO 60x and 100x oil immersion objectives are provided as an option for a VS120-S6-W configuration.



Virtual-Z with 3D Virtual Slide Production

The VS120 can scan multiple large specimens through up to 31 Z-planes. Multi-plane virtual slides can then be produced by simply selecting attributes such as depth for multiple areas, range, number of planes, and magnification within the virtual-Z scan mode. Virtual-Z scanning also allows the user to adjust the image to the specific desired depth with the simple scroll of a mouse — a function particularly advantageous for the viewing of thicker specimens, such as cell clusters or cranial nerves.

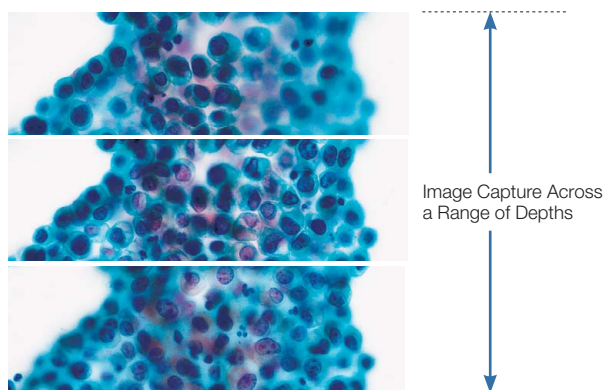

Accurate Image Stitching, Regardless of Specimen Quality

A newly developed algorithm makes image stitching with the VS120 so precise, it can even capture quality composite images across large and uneven specimen regions.

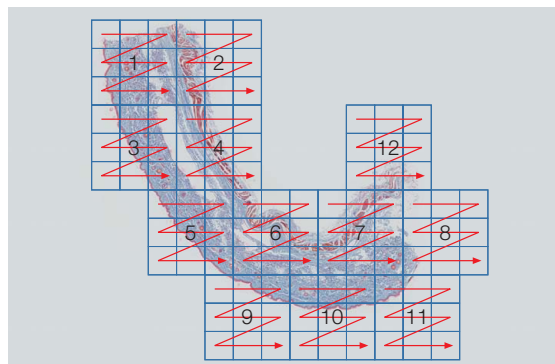

VS120 minimizes stitching errors by automatically recognizing only where specimen exists then integrating images of consecutive areas.

Supporting High-Resolution, High-Sensitivity Virtual Fluorescent Slides

High-speed filter wheels of the fluorescent unit can be installed on both the excitation and observation side, enabling the swift production of fluorescent virtual slides with high-level definition and resolution. Multi-colored virtual slides also can be prepared for long-term observation, negating concerns over fading, discoloration, and degradation.

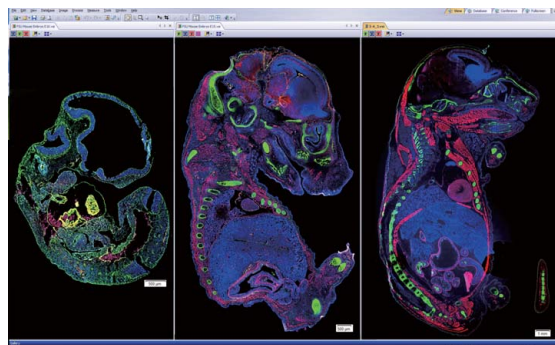

Automation Enhances Laboratory Efficiency

An optional automated slide loader with a capacity to hold 100 slides adds efficiency to laboratories with high throughput requirements. Furthermore, specimen information can be automatically read using 1D and 2D barcode scanner, making it easier to store and organize information.

Functionality to Serve a Range of Observation Needs

Select the Desired Scanning Area without the Need to Adjust Settings

Because the VS120 displays the scan area and focus mapping settings on the same screen, the desired scan area can be selected in an instant — bringing greater efficiency to overall workflow by doing away with the need to switch screens.

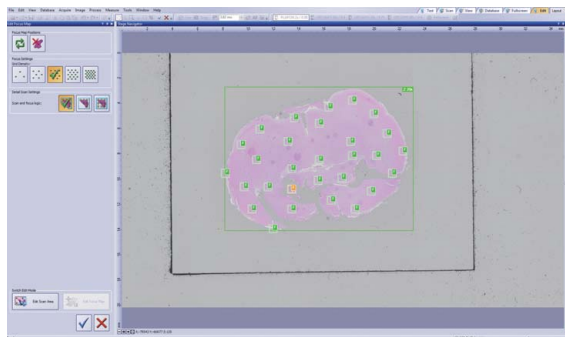

An Innovative Synchronizing Feature Enables Comparative Viewing of the Same Sample Under Different Stains

Analysis of the multiple virtual slides prepared from the same specimen is made easy through the ability to align them on the monitor with positions and magnifications interlinked.

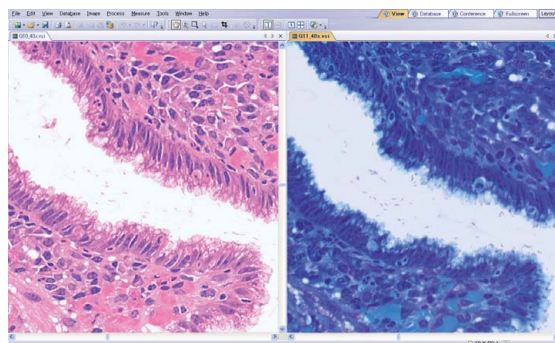

View Full and Magnified Images on the Same Screen

Both the whole slide and zoomed-in region can be displayed on the same screen, making it easy to pinpoint the specific location on the larger image.

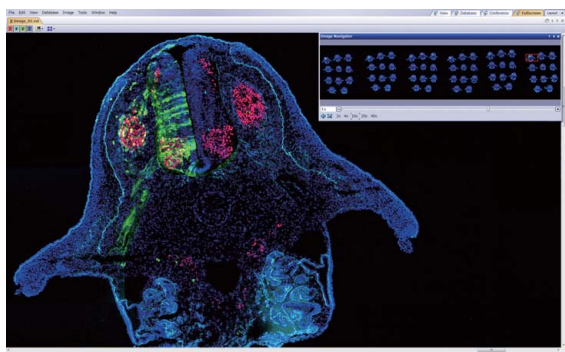

EGFP-electroporated chick embryos
DAPI (blue), EGFP (green), Islet1/2 (red), laminin (Cyan)

Image data courtesy of:
Hiroshi Yajima, Ph.D., Kiyoshi Kawakami, Ph.D.
Division of Biology, Center for Molecular Medicine,
Jichi Medical University

Save Annotation Voice Data

An innovative annotation function allows the user to save and link text and voice data to specific regions of interest on the slide.

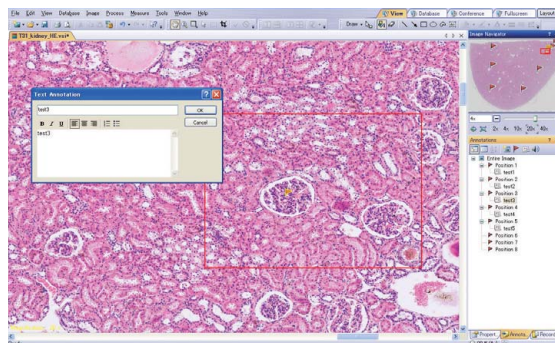

Capture Clear Images with All-in-Focus Imaging for Fluorescence

With the aid of virtual-Z scan mode, in-focus image data at different focal planes throughout the whole Z-direction can be captured and on-the-fly be merged using the Extended Focal Imaging or Z-projection function to generate an all-in-focus image. This allows to visualize and observe fluorescence in irregularly shaped or thick samples, such as FISH samples.

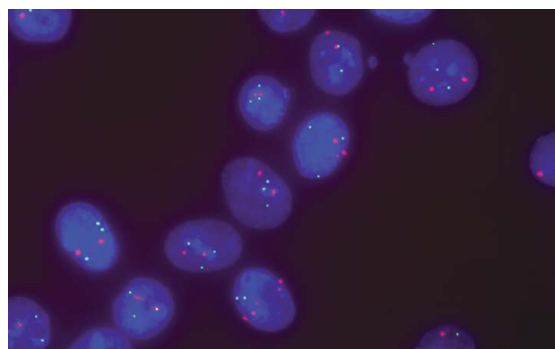

A Database Providing Simple Operation (Option)

Powerful and Fast Search Functionality

Virtual slides are easily found by using keywords through the folder tree. Simply double-clicking on the corresponding thumbnail image opens the desired virtual slide in a new window.

SQL-based Net Image Server

Building on the importance of high throughput, the optional, versatile Net Image Server SQL client server database, allows users to manage any image in a simple and convenient way. The database software allows to store images and share image data via web, such that the virtual slide images from VS120 can easily be released and shared to a wide audience. Access to the image data can be controlled via individual access rights.

Attach Metadata to Virtual Slides

The VS120 provides editable metadata fields that can be used to store data such as tissue name, staining method, organ name, system, instructor's name and other keywords. Such information appended to slides, can assist greatly in an educational setting.

Example of a Virtual Slide Search

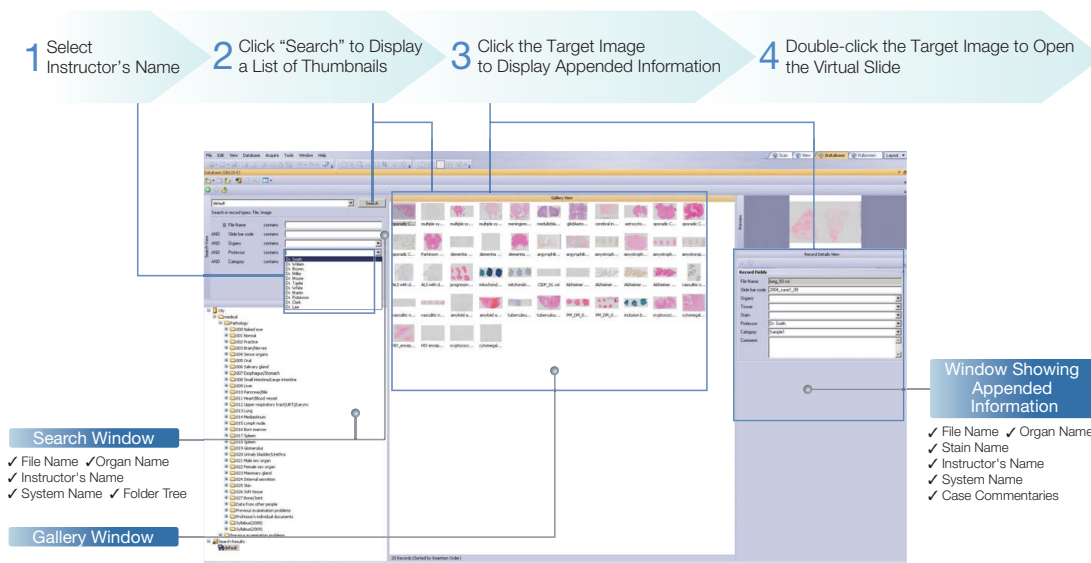

Batch Management of Digital Content

Offering functionality beyond virtual slides, the VS120 allows a wide range of image data to be archived to a database in both JPEG and TIFF formats, including macro images captured by other devices such as endoscopic images, X-ray images and electrocardiograms. Users are also able to save Microsoft Word, Excel and PowerPoint documents to the database.



Specifications

		VS120-S6-W	VS120-L100-W
Intended Specimen	Observable Specimen	Glass slide with cover glass	
	Size of Glass Slide	Width: 25mm–26mm, length: 75mm–76mm, thickness: 0.8mm–1.4mm	
	Size of Cover Glass	Thickness: 0.12mm–0.17mm	
Microscope Frame	Illuminator	Built-in Koehler illumination for transmitted light	
	Objectives	2x, 10x, 20x, 40x, 60x* ¹ and 100x* ¹ oil immersion with a motorized revolving nosepiece	2x, 10x, 20x, 40x with a motorized revolving nosepiece
	Motorized Stage	Motorized XY stage with automatic control	
	Focusing	Motorized automatic control	
	Fluorescence Observation (option)	Motorized fluorescence illuminator, Motorized filter wheel, Fluorescence light source (Mercury lamp: U-HGLGPS or LED: Lumencor SOLA* ²), Digital monochrome camera (Olympus XM10 or Hamamatsu ORCA Flash4.0 V2)	
Digital Camera	CCD Camera	2/3" CCD camera, 3.45µm x 3.45µm pixel size, high sensitivity, high resolution	
	Image Correction	Shading correction, auto white balance	
Scan	Capacity	6 slides (maximum) (manual)	100 slides (maximum) (automatic)
	Scan Area	W 26mm x H 64 mm (Slide glass size: W26mm x H76mm)	
	Pixel Resolution* ³	20x (NA 0.75): 0.33µm/pixel 40x (NA 0.95): 0.17µm/pixel 60x oil immersion (option, NA 1.35): 0.11µm/pixel 100x oil immersion (option, NA 1.4): 0.07µm/pixel	20x (NA 0.75): 0.33µm/pixel 40x (NA 0.95): 0.17µm/pixel
	Scan Time	Approx. 2 min. (20x objective, scan area 15mm x 15mm brightfield)	
	Software	Image format: vsi, JPEG, TIFF/zooming while scanning/annotations/automatic sample detection/Z stack extended focus imaging/screen capture/stepless zooming/synchronized multi-images display/automatic stitching/slide loader control/consultation software (option)	
	Environment	Weight	Approx. 55kg (incl. controller and display)
Operating Environment		Temperature: 15–28 degree centigrade, humidity: 30%–80% (non condensing)	
Power		Scanner: AC 100–120/220–240V, 50/60Hz, 3.5A/1.5A Controller: AC 100–240V, 50/60Hz, 9.5A Display: AC 100–240V, 50/60Hz, 1.5A Slide loader: AC 100–120/220–240V, 50/60Hz, 0.9A/0.5A (VS120-L100-W only)	
Power Consumption		960W	1030W

*¹ Option. *² Not available in some areas. *³ This value is length per pixel of the specimen surface.

Dimensions

(Unit: mm)

Fluorescence Observation Configuration (With 6-slide Storage Capacity)

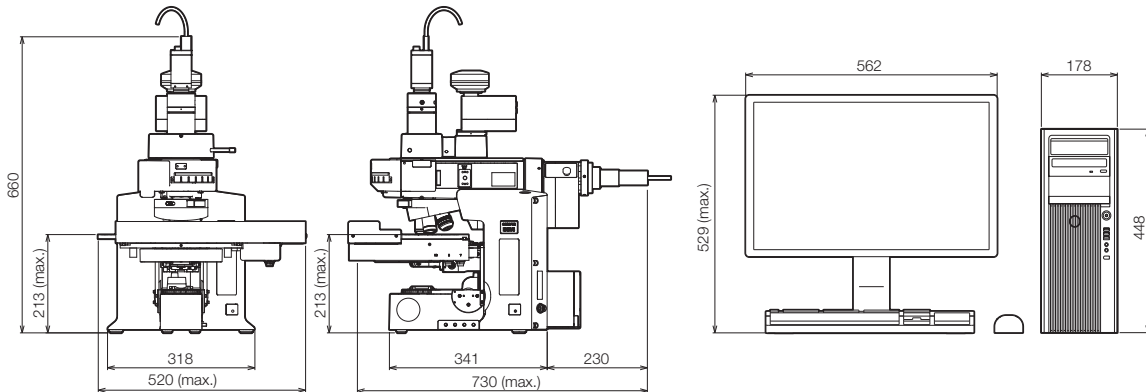

Brightfield Observation Configuration (With 100-slide Storage Capacity)

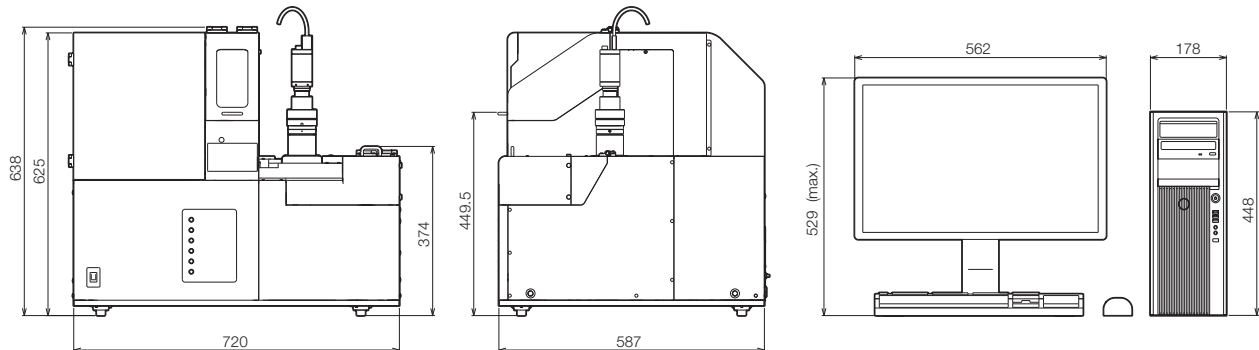

- OLYMPUS CORPORATION is ISO14001 certified.
- OLYMPUS CORPORATION is ISO9001 certified.
- Illumination devices for microscope have suggested lifetimes. Periodic inspections are required. Please visit our website for details.

- All company and product names are registered trademarks and/or trademarks of their respective owners.
- Images on the PC monitors are simulated.
- Specifications and appearances are subject to change without any notice or obligation on the part of the manufacturer.

www.olympus-lifescience.com

OLYMPUS[®]

OLYMPUS CORPORATION
Shinjuku Monolith, 2-3-1 Nishi-Shinjuku, Shinjuku-ku, Tokyo 163-0914, Japan